

D-STANDARD
BORE GAGE #3

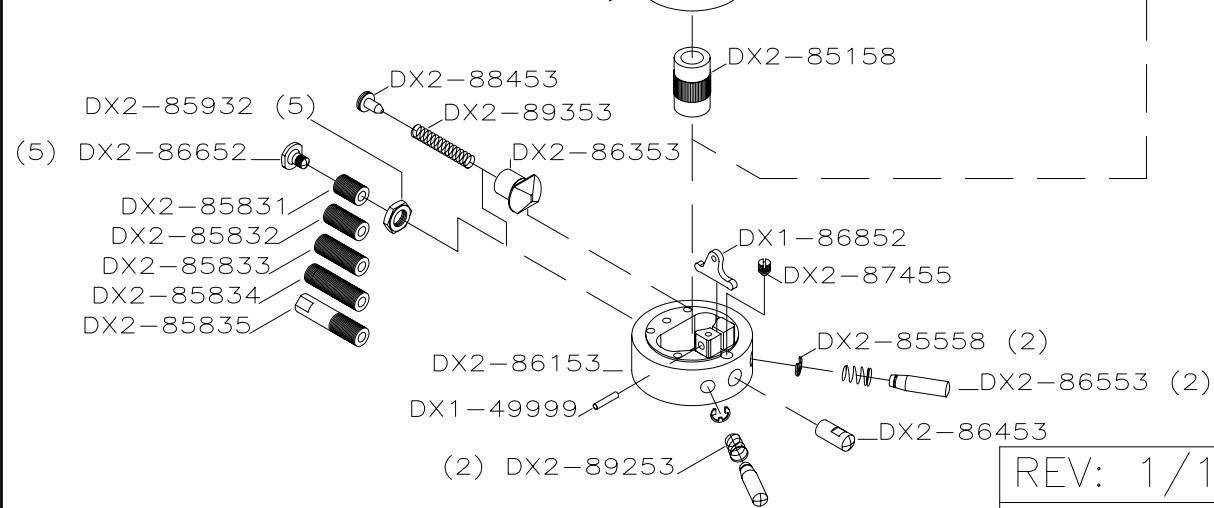
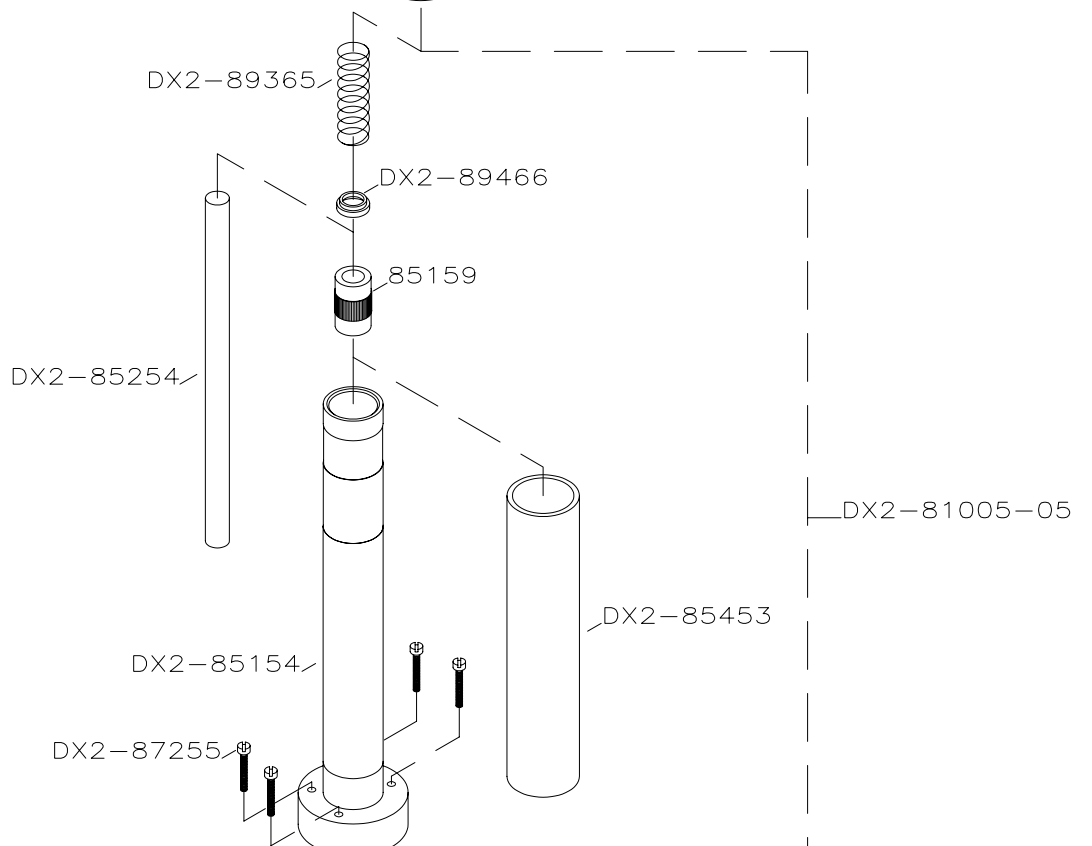
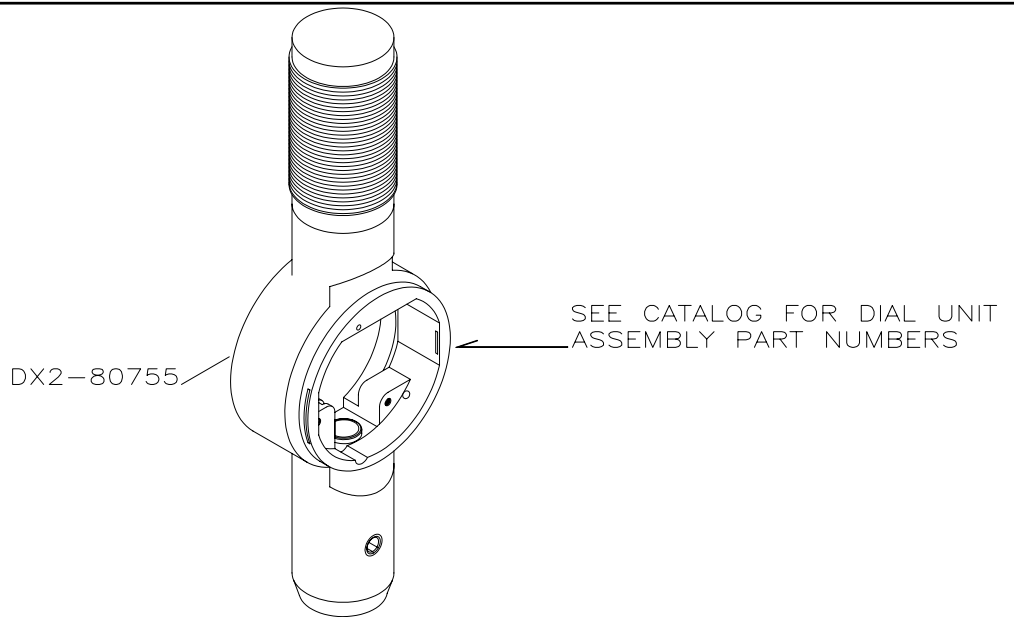
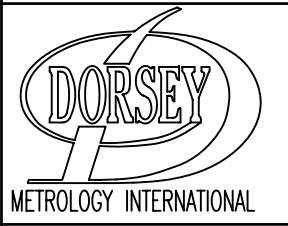

REV: 1/18/2008
FILE: DBG#3 ASSY.dwg